

Diesel/LPG Combi Air and Water Heater

LCD Switch Operation Manual

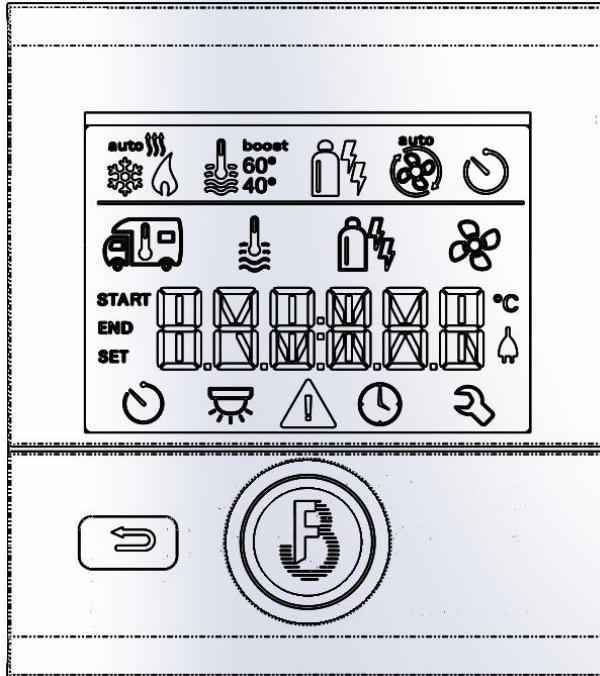

December 25th, 2020 Edition

Preface

Thank You for Using JP Heater Combi Air and Water Heater

This product supports the heating of water or motor home or both with either eclectic mode or liquefied petroleum (or fuel), making trip more convenient and comfortable.

This manual describes the use method, installation instructions, technical parameters and fault inquiries of the LCD switch of the integrated air and water heater (referred to as LCD switch). Please read this manual carefully before use. Please keep it in a safe place for future reference.

Security warning:

1. If the information in this manual cannot be read or executed accurately, fire or explosion may be caused, resulting in property damage, personal injury or death.
2. Do not store flammable, explosive or volatile gas or liquid holding equipment near the Heater.

If you smell the gas:

- Evacuate passengers from the vehicle.
- Turn off the gas supply to the gas container or gas source.
- Do not touch any electrical switches or use any phone or radio in the vehicle.
- Do not start the engine or generator of the vehicle.
- Do not start the gas supply until the gas leak is detected.

Installation and service must be performed by certified service technicians, service organizations, or gas suppliers.

3. The Heater must be installed in motor home or trailer.
4. The LCD switch can only be used when the whole equipment is installed properly.
5. Please correct any malfunctions immediately. The remedy specified in the troubleshooting table in these operating instructions can only be repaired by itself.
6. Do not perform any repair or modifications on the LCD switch! Any changes to the device or its controls can be dangerous and will void the warranty.
7. Defective LCD switch can only be repaired by the manufacturer or the service department of the manufacturer.
8. Do not use the Heater in garages, multi-storey vehicle parks or ferries or during refueling. Turn off the Heater with the LCD switch to ensure that the Heater cannot be turned on by remote control.

Important information:

If a new heater or a heater for replacement is connected to the LCD switch, the process described in "Power On Start" must be repeated.

I. Display and Control

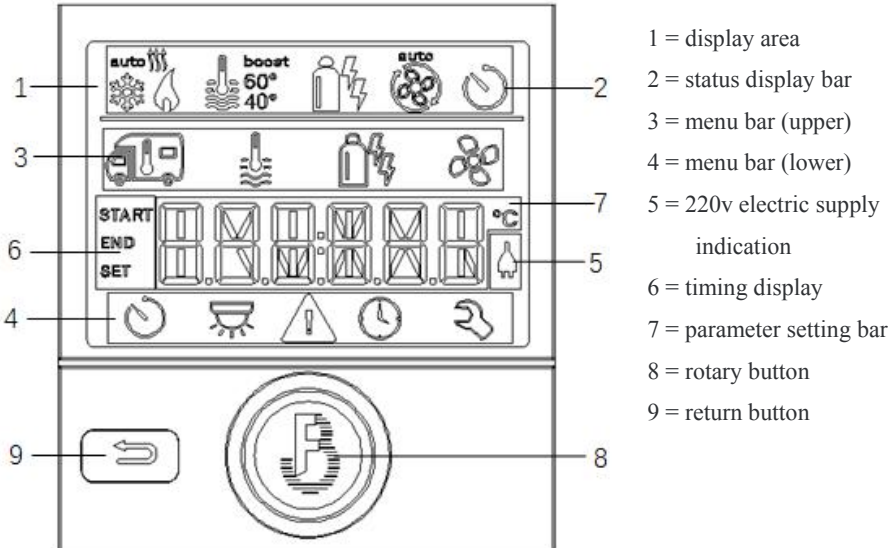

-- Information is displayed on the LCD display with backlight.

-- In the menu bar (3, 4), the function of the LCD switch can be arbitrarily selected. The operating parameters are displayed on the status bar (2) and display (5, 6).

After the 220v supply is connected, the 220v electric supply indication bar (5) displays the power supply flag.

-- During operation, set the parameter bar (7) to display the change between time and set room temperature.

-- Press the return button to disable selected parameters and return to the previous interface.

Rotary button

Select, modify, and save icons for menu bars 3 and 4 with the rotary button. The selected icon flashes.

Clockwise rotation indicates:

--Options scroll from left to right of one menu bar, from the end of one menu bar to the front of another menu bar.

-- Increase the numerical value by one.

--Options scroll from right to left of one menu bar, and from the front of one menu bar to the end of another menu bar.

-- Reduce the numerical value by one.

Tapping of the rotary button indicates:

--Confirm and store the selected option and return to the main menu.

Long press of the rotary button (more than 3s) indicates:

-- The Heater's heating function or other functions are turned off and the LCD switch is turned off to enter the sleep state.

Return button

-- Discard the current option and return to the previous option.

Counterclockwise rotation means:

II. Switch setting

1. Power on

When the LCD switch is powered on, "INIT. ." will appear on the display. After a few seconds, the time 00:00 will be displayed.

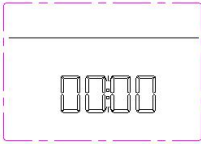
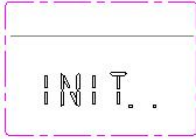

Click the rotary button to display the initial interface options in the display area.

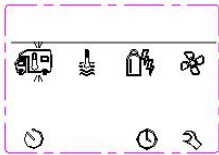

Timing (current time setting)

Click the rotary button to display the icon in the menu bar (3).



-- Use the rotary button to select the "Set Clock" icon in the menu bar (4).

-- Click the rotary button to enter the clock settings.

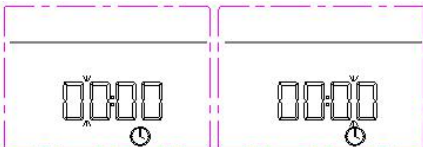

--The hour display flashes.

--Use the rotary button to set the time.

"A--" is displayed in the morning and "P--" is displayed in the afternoon, which is automatically switched.

--Click the rotary button again to determine the time, then the minute display flashes.

--Set the minute with the rotary button.

--Click the rotary button to confirm the value and exit the clock setting.

2. Start with rotary button

--Press the rotary button for a long time (more than 3s), and the LCD switch will start.

3. Shutdown

Press the rotary button for more than 3s at the initial interface to shut down. When the LCD switch is turned off, the heating process and any connected equipment are also automatically turned off. The parameters before shutdown are retained.



Halt process

Since the Heater has a higher residual heat after heating and a post-cleaning need (cleaning of combustion room after combustion), the fan operation will be delayed for a few minutes to cool.

III. Heating Function Setting

For the heating function setting, it is necessary to set the energy first, then choose water heating or room heating or simultaneous heating, and finally set the circulating wind speed. The default heating function settings include the energy setting gas and the circulating wind speed setting eco.

1. Energy setting

Click the rotary button to display the icon in the menu bar (3). Rotate the button to select the energy icon in the menu bar (3).

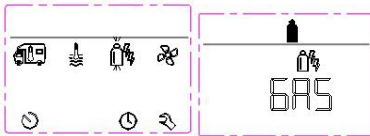

- Click on the selected icon.
- Use the rotary button to select the desired energy mode.
- Click the rotary button to confirm.

Working mode Energy mode

Gas	Liquefied petroleum gas / diesel
Mix 1	Electric supply 900 w + gas
Mix 2	Electric supply 1800 w + gas
E1 1	Electric supply 900 w
E1 2	Electric supply 1800 w

If the energy type is not selected, once the heater starts to operate (room temperature, hot water icon is activated), the status bar shows the type of energy selected during the previous heating or the default energy type gas.

2. Indoor temperature adjustment

Click the rotary button to display the icon in the menu bar (3).



--Select the room temperature heating system with the rotary button depending on the connected device.

--Confirm the option by clicking the rotary button on the selected room temperature icon.

--Use the rotary button to select the desired temperature.

--Click the rotary button to confirm its value.

Temperature display	Adjustment range	Step
°C	5~30 °c	1 °C

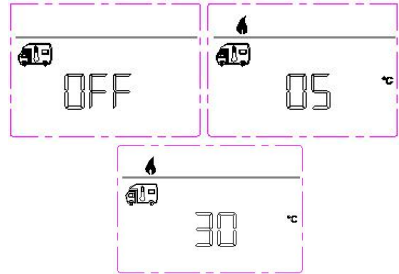

Flame icon = room temperature heating start. This icon will flash until the predetermined room temperature is reached.

3. Water heating adjustment

Click the rotary button to display the icon in the menu bar (3).

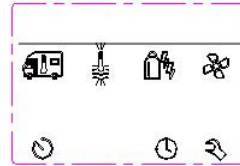

--Use the rotary button to select an icon in the menu bar (3).

--Click the rotary button to confirm and enter the setting level.

--Use the rotary button to select the desired water temperature setting level.

--Click the rotary button to confirm the value.

Working mode	description
OFF	Water heating is closed. Water heating icon disappears
ECO	Presetting water temperature 40 ° C
HOT	Presetting water temperature 60 ° C
BOOST	Performing water heating for 40min first or heating room after water temperature reaches 60 ° C

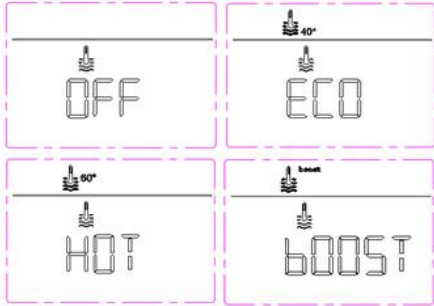

This icon will flash until the predetermined water temperature is reached.
 In the "heating and hot water mode", the water temperature of 40°C can only be stored for a limited time (room heating priority).

4. Selection of wind speed

Click the rotary button to display the icon in the menu bar (3).

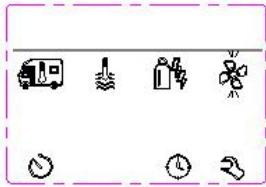

- Rotate the button to select an icon in the menu bar (3).
- Click the rotary button to confirm and enter the setting level.
- Use the rotary button to select the desired fan speed.
- Press the rotary button to confirm and save.

Working mode	description
OFF	Turn off the fan.
VENT	Circulation ventilation. The 10-level wind speed can be selected. Wear of the motor may increase depending on the frequency of use.
ECO	Low wind speed
LOW	Intermediate wind speed
HIGH	High wind speed which results in higher power consumption, higher noise level and increase of motor wear.
BOOST	The room will heat up quickly

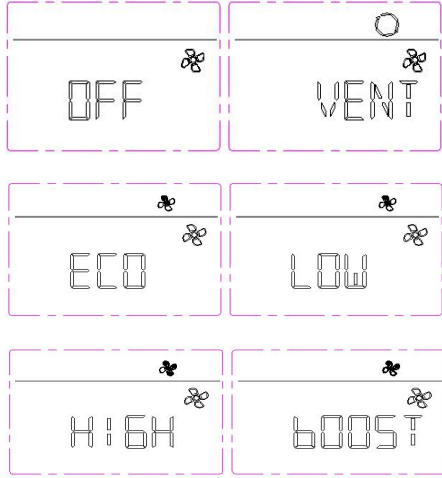

5. Start heating

After the setting is finished, press the back key or wait for 10s to enter the timing interface, and the heating starts. Time and set temperature are displayed alternately.

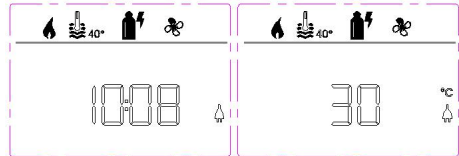

6. Stop heating

Press the rotary button for more than 3s to shut down.

IV. Timing heating setting

Click the rotary button to display the icon in the menu bar (3). Click the rotary button to enter the timing setting.

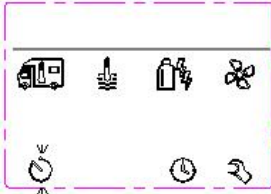

Warning: Danger of toxic exhaust gases.

The activated timing switch will turn on the Heater even if the vehicle is stopped and there are no operators. Exhaust gases from the Heater may be toxic in confined spaces such as garages, workshops, repair shops.

If the vehicle is parked in a closed room:

- Turn off the fuel supply to the Heater.
- Turn off the timing switch of the LCD switch.

-- Turn off the Heater with the LCD switch. Press the rotary button for 3 seconds to turn it off.

1. Start time entering

Use the rotary button to set the start time. Click the rotary button to confirm and proceed to the next setting.

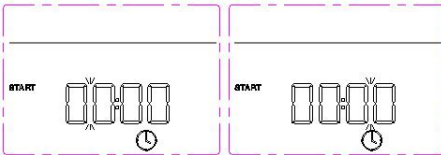

2. End time entering

Use the rotary button to set the heating end time. Click the rotary button to confirm and proceed to the next setting.

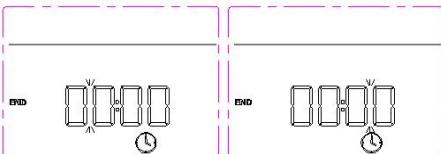

3. Room temperature setting

Use the rotary button to select the desired room temperature. Click the rotary button to confirm the value.

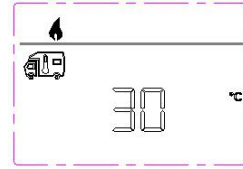

4. Water temperature setting

Use the rotary button to select the desired hot water temperature. Click the rotary button to confirm.

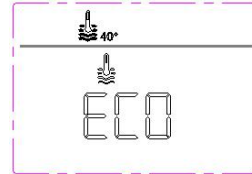

5. Energy mode selection

Use the rotary buttons to select the desired energy mode. Click the rotary button to confirm the value.



6. Fan speed level selection

Use the rotary button to select the desired fan speed level. The fan speed level is selected only after the room temperature heating mode is set. Click the rotary button to confirm.

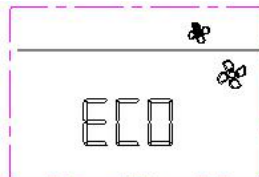

7. Timing enabled

Use the rotary button to select Enable Timing (on). If OFF is selected, the timing is canceled, but the setting is saved. Click the rotary button to confirm that the timing is valid.

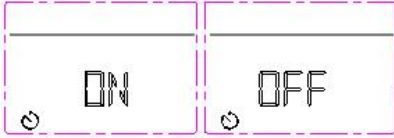

The timing switch remains enabled only once until it is disabled (turned off) or powered down. If the time switch is programmed and enabled, the timing switch icon is displayed in the status line (2). The timing icon flashes if the time switch is enabled and activated.

8. Timing cancellation

After timing is set, use the rotary button to select the timing setting. Click the rotary button to enter the setting.

Use the rotary button to select the timing cancellation (off). If on is selected, continue to use timing. Click the rotary button to confirm that the timing cancellation is valid. But the previous settings are still saved.

V. Parameters Setting

The specific parameter setting will remain after the power is turned off. Use the rotary button to select the "setting" icon in the menu bar (4). Click the button to enter the setting.

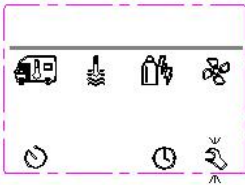

1. Voltage inquiry

Click the rotation button to display the voltage: 12.0V.

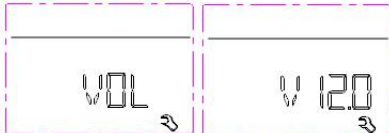

2. Air pressure and temperature inquiry

Use the rotate button to select the atoms icon.



Click the rotation button to enter the query.

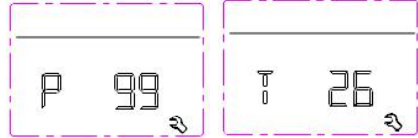

Use the rotary button to switch between atmospheric pressure and ambient temperature.

Atmospheric pressure: 99KPa
Ambient temperature: 26 °C

3. Offset setting

The external temperature sensor of the Heater can be adjusted separately depending on the installation of the sensor. The offset setting can be in the range of -5 ° c to 5 ° c, with an error of 1 ° c. Use the rotary button to select the offset icon and click the rotary button to enter the setting. Use the rotary button to select the offset value. Click the rotary button to confirm and save.

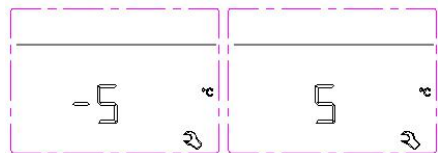

4. Switching temperature units

Use the knob to switch between centigrade and Fahrenheit, and click OK.

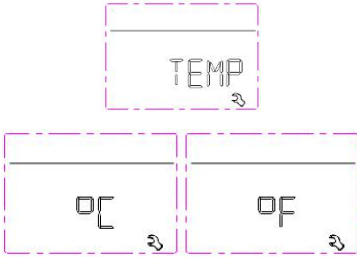

5. LCD backlight adjustment

The LCD backlight has 10 levels of incremental adjustment. Use the rotary button to select the BRIGHT icon and click the rotary button to enter the setting. The brightness of the LCD changes as the rotary button rotates. After confirming by clicking the rotary button, return to the previous operation. The backlight brightness is set to level 6 by default.

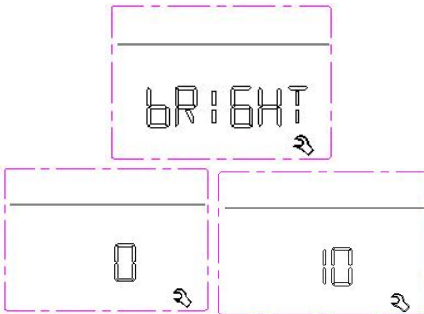

6. Time format setting

Use the rotary button to select the time format setting icon and click the rotary button to enter the setting. Use the rotary button to select the 12h icon or the 24h icon and click the rotary button to confirm. The default setting is 24h.

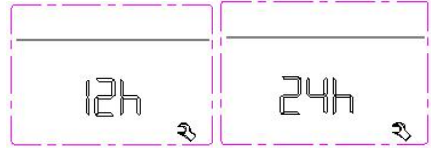

7. Fast oil pumping setting

Use the rotary button to select the oil pumping icon GoOilL.

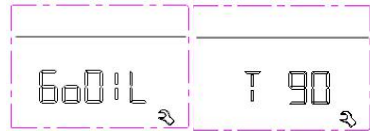

Click the rotary button to enter the fast oil pumping. The default fast pumping time is 90 seconds. The remaining time can be adjusted with the Rotary button.

Stop the fast oil pumping by pressing the return button or when the pumping time exceeds the set value.

8 Software version number

Use the rotary button to select the INdEx icon and click the rotary button to enter the query item. Use the rotary button to view the information of the LCD switch or the information of the main controller. Click the rotary button or the return button to return to the previous operation.

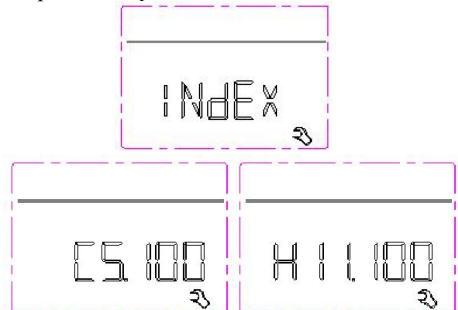

C5.100--LCD switch version
H11.100--main controller version

9. Factory settings

The reset function resets the LCD switch to factory settings. All previous settings will be deleted. All devices used before reset should be installed and powered.

Use the rotary button to select the RESET icon and click the rotary button to display the factory settings PR SET. After clicking to confirm, the initialization "INIT....." is displayed.

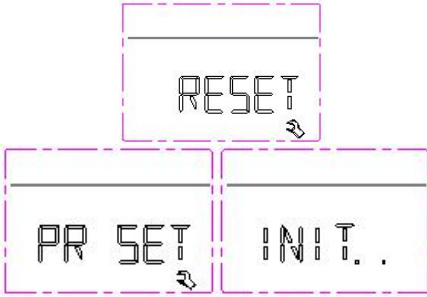

VI. Fault Display

How to read the alert code:

-- Use the rotary button to select the  icon and click the rotary button to display the current warning code (for troubleshooting, please refer to the relevant heater operation manual).

Faults include faults recovering automatically and faults recovered manually after repair.

A fault recovering automatically is a warning fault in which an operating parameter has exceeded a defined range of normal operation and reaches an undefined state. In this case, the equipment will continue to run and the warning symbol () will be displayed in the menu bar (4) without warning code. After the fault is repaired, the warning symbol disappears automatically (it can also be manually restored), and the equipment continues to work according to the original settings. For example: warning fault code W120H.

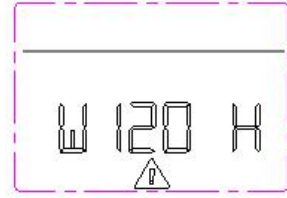

A manually recovered fault means that the fault code is displayed in the parameter setting bar (7) when the fault occurs. The cause of the fault can be determined and remedied by the help of the troubleshooting guide. The fault code disappears after a few seconds, and the warning also disappears. The warning symbol is displayed in the menu bar (4).

To select reheating after the fault is identified and resolved, eliminate the fault code first. Press the rotary button to display the fault code. Then, press the rotary button again, the displayed fault code disappears and the interface returns to the initial time interface. Re-enter the heating parameters to initiate heating. If the fault is eliminated, the heating will be normal. Otherwise, the fault will occur again. The LCD switch will jump to the "Fault" menu again, and the warning symbol will be displayed again. The affected equipment will still be in the warning state. Since the fault has not been eliminated, if you want to return to the setting level, press the return button (9).

For example: fault code E31H. Shutdown and power-off can also eliminate faults.

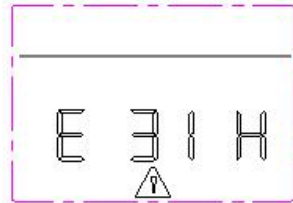

The fault code table and troubleshooting methods can be found in the tenth fault code table at the end of the manual.

VII. Technical Parameters

Display: LCD, black and white, with backlight.

Dimensions: 92 × 103 × 40mm

Working temperature: -25 °C ~ +60 °C

Storage temperature: -25 °C ~ +70 °C

Power supply: dc10.5~16v

Power consumption: Max.65mA (100% backlight)

Standard current: 10mA

Quiescent current: 3mA

The above parameters are subject to change without notice.

Maintenance:

The LCD switch is maintenance-free. To clean the front panel, use damp cloth or neutral soap solution.

VIII. Installation Instructions

Installation in vehicles must comply with applicable technical and administrative regulations.

Security information:

Installation and service must be performed by authorized installers and service agents. Improper installation, alteration, repair, or maintenance can result in property damage, personal injury, or loss of life, and the warranty will also be canceled.

Do not try to install the equipment by yourself. Do not use high voltage equipment unless the electronic circuit (board) is disconnected. Do not use a battery charger to power the Heater, even while testing. If the vehicle requires electric welding, do not connect a 12 volt DC power supply to the equipment. Electric welding can cause serious damage to the equipment. Do not shorten the electrical connection cable or remove the label indicating polarity. Turn off the vehicle's vehicle power supply during installation and turn off the power when the equipment is connected. The equipment can only be installed in the specified location.

When the gas heater is not used, it is best to turn off the gas valve.

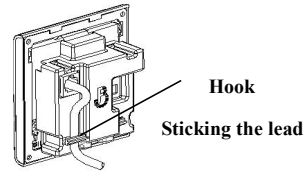

Figure 1

Installation location:

Install the LCD switch in a waterproof and moisture-proof position.

Install the LCD switch at the height of your eyes for easy reading and operation.

Prepare a mounting opening for the LCD switch, as shown in figure 2.

Lay the connector cable connecting the cables in a tension-free circuit. It shall be able to pull the LCD switch out of the mounting hole by 20 cm so that no tensile stress is applied to the plug connection. Never pulling the connector cable connecting to the LCD switch.

Assembly:

Install as shown in Figure 3.

Install the LCD switch holder to the wall with 4 m3×10 screws.

- ① Hang the front panel of the LCD switch on the holder
- ② Fasten the LCD switch to the holder
- ③ Secure the LCD switch with m3×6 screws.
- ④ Install the rotary button (figure 3-4) onto the shaft.

LCD switch installation opening diagram

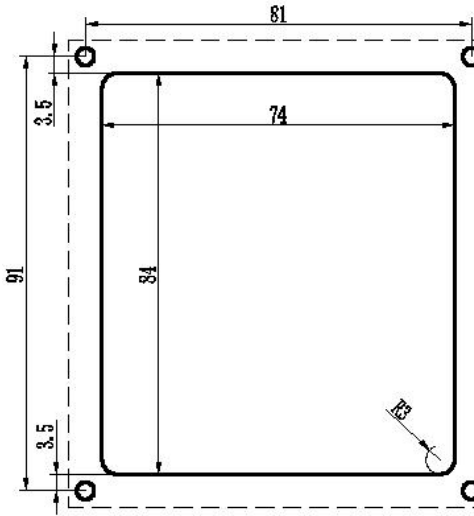

LCD switch installation method

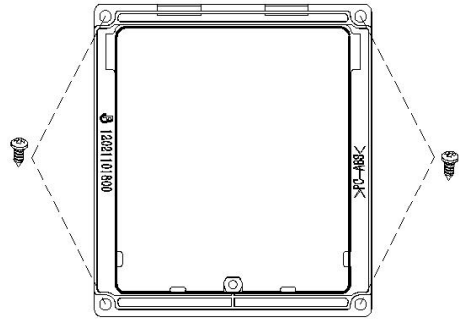

Figure 2

IX. Attachments

Name	Quantity
LCD switch	1
Cross countersunk head and flat tail self-tapping nail m3×6 (fastening the switch panel)	1
Cross head self-tapping nail m3×10 (installing the switch on the wall)	4
Operation and installation instruction	1
Connecting cable, a length of 6m	1

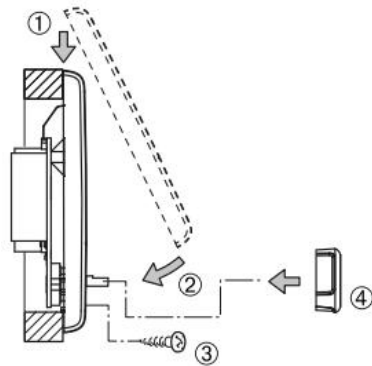

Figure 3

X. Troubleshooting Method

Troubleshooting Method for Fault Locking State		
Fault code	Fault name	Troubleshooting methods
10	Extremely high voltage	a check vehicle power supply system
11	Extremely low voltage	a check vehicle power supply system
21	Open circuit of warm air outlet temperature sensor	a check whether the sensor is in good condition.
22	Short circuit of warm air outlet temperature sensor	a check whether the sensor is in good condition.
23	Open circuit of water temperature sensor	a check whether the sensor is in good condition.
24	Short circuit of water temperature sensor	a check whether the sensor is in good condition.
25	Open circuit of external temperature sensor	a check whether the sensor is in good condition.
26	Short circuit of external temperature sensor	a check whether the sensor is in good condition.
27	Open circuit of combustion-supporting temperature sensor	a check whether the sensor is in good condition.
28	Short circuit of combustion temperature sensor	a check whether the sensor is in good condition.
31	Ignition failure	a check the diesel supply system b check whether the combustion-supporting inlet and outlet are blocked c check glow plug and flame sensor
32	Combustion failure	a check the diesel supply system b check whether the combustion-supporting inlet and outlet are blocked c check the flame sensor.
33	Flame sensor failure	a check flame sensor leads b check flame sensor

41	Warm air outlet temperature is too high	a check whether the air inlet and outlet are blocked
42	Warm air overheat switch protection	a check whether the air outlet is blocked b check the heater overheat switch
43	Water temperature is too high	a check whether the water tank is short of water. b check whether the sensor is in good condition. c check whether the air outlet is blocked
44	Water temperature overheat switch protection	a check whether the air outlet is blocked b check the water temperature overheat switch
45	Continuous overheat fault	a check whether the air outlet is blocked b check the water temperature sensor c check heater sensor
51	Communication failure	a check the connection cable
61	Open circuit of oil pump	a check whether the oil pump lead is damaged b check whether the oil pump lead connection is reliable. c replace oil pump d replace motherboard
62	Oil pump short circuit	a check whether the oil pump lead is damaged b check whether the oil pump lead connection is reliable. c check oil pump d replace motherboard
63	Open circuit of glow plug	a check power supply voltage b check the normal temperature resistance of glow plug (0.2Ω/12V) c clean up carbon deposits in glow plug d replace motherboard
65	Glow plug has no drive	a replace motherboard
71	Gas valve failure	a Check gas valve coil and lead
72	Gas valve power failure	a Replacement motherboard
81	Open circuit of combustion-supporting fan	a check combustion-supporting fan
82	Combustion-supporting fan failed to	a check motor lead connection

	start	b check combustion-supporting fan
83	The speed of combustion-supporting fan is too low.	a check combustion-supporting fan
84	Open circuit of heater fan	a check the heater blower.
85	The warm air blower failed to start.	a check motor lead connection b check the heater blower
86	The speed of warm air blower is too low.	a check the heater blower.
91	High voltage package failure	a Check the ignition coil and lead
92	High voltage power supply failure	a Replacement motherboard
93	High voltage circuit failure	a Replacement motherboard
94	Gas valve circuit failure	a Replacement motherboard
110	Window opening alarm	a check window switch connection cable
120	Low voltage alarm	a recommend charging
220	220V no connection	A check AC 220V power supply system

If these measures cannot correct the fault, or the fault code is displayed, it cannot be found in the fault code table guide, please contact the service provider.

Table 2 continued

Official website:

Alibaba store:



JP China Trade Int'l Co., Ltd.

Wangdapeng@jpchinatrade.com

Candyli@jpchinatrade.com